



Hotham Fireplace Installation Instructions

Build, rendering, firebricks and accessories



Scan me to view
sample installation
video

www.ochreliving.com.au



OCHRE LIVING

Cover photo by L. Davies | July 2021

Please note that the images show the version with the optional bottom log storage.

Hotham

Top Cap x 1

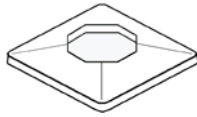

Chimney Blocks x 3

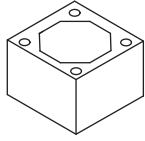

Top Plate x 1

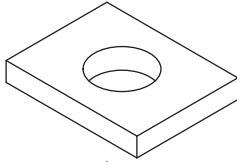

Gather front, back and sides x 4

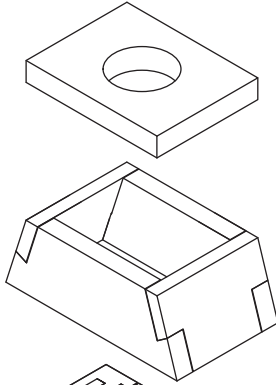

Sides and back x 3

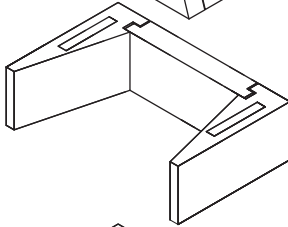

Sides and back x 3

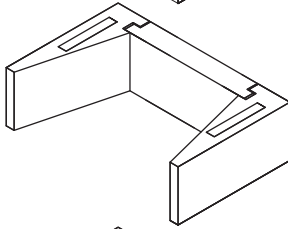

Sides and back x 3

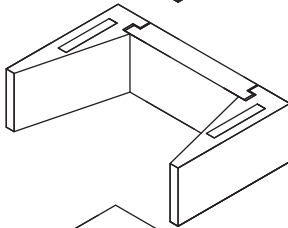

Base Plate x 1

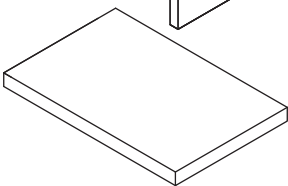

The Hotham comes complete with the following components:

- 1 bag of Jointing Adhesive (for pumice components)
- 2 bags of External Render
- 1 log retainer kit (2 metal bars + 2 fixing brackets)
- 1 bag of Calderys Firebrick Mortar
- 1 set of pre-cut firebricks (see diagram below)

Fire brick diagram and parts for the Hotham (see page 8 for more details)

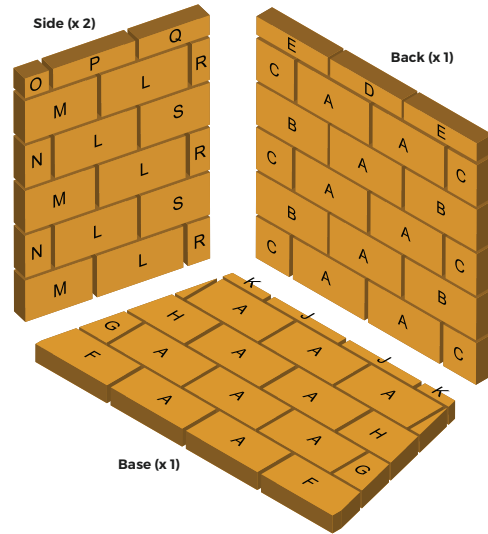

Log retainer kit (see page 10 for more details)

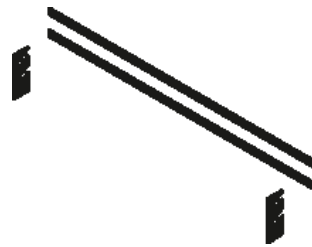

Log Storage component parts

(supplied only if this option has been purchased)

2 sides, 1 back and 1 central block

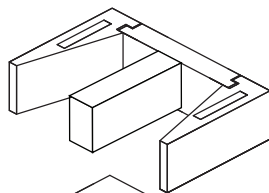

Base Plate x 1

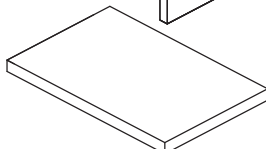

Preparation

The Hotham needs to be built onto a firm foundation. It should not be built directly onto decking. Ochre Living recommends that a minimum 100mm reinforced concrete base is used to support the structure.

A distance of 75mm should be left between the Hotham and any wooden or other combustible material.

Tools Required



Instructions - Optional Log Storage (If this has not been purchased, go to page 4)

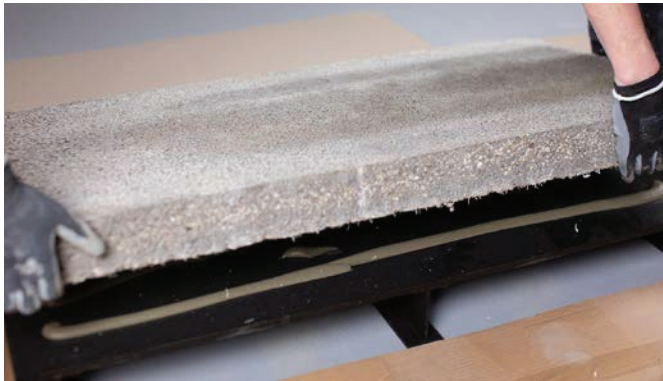

Create a suitable base. We recommend 100mm thick reinforced concrete. Bed the base plate using the supplied jointing adhesive. Check every stage is level.



Mix jointing adhesive as per instructions on the bag. Apply 15-20mm beads using the supplied application bag as shown in the picture above.



Press one side block into place and apply jointing adhesive into the slot as shown.



Press back panel into place and then add the remaining side panel.



Press the middle section down on to the jointing adhesive and apply additional adhesive as shown.



Press the base plate of the firechest down on to the log storage. Keep checking all is level and remove any excess jointing adhesive.

Installation Instructions - Firechest (Step 1)



Bed the base plate using the supplied jointing adhesive onto the log storage or a suitable 100mm thick reinforced concrete bases. Check every stage is level.



Press one side block into place and apply the jointing adhesive into the slot as shown.



Press back panel into place and the other side block.



Apply the jointing adhesive on top of the first layer.



Add a further 2 layers of side blocks and back panels applying jointing adhesive between each layer and at each joint. In total there are 3 layers on top of the base plate, as per the image. (If the log storage option is not being used, then this base plate will be bedded directly on to a suitable prepared base).

Step 1 Base, sides and back complete

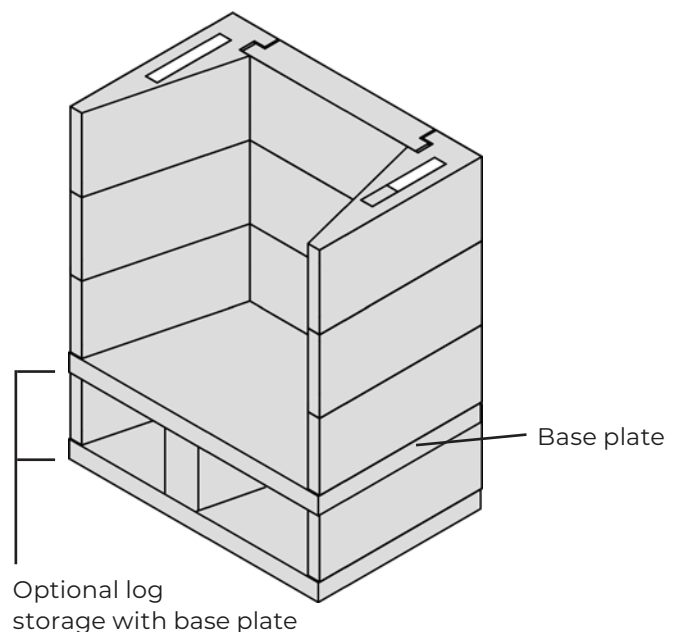

Instructions - Gather Unit (Step 2)



Apply jointing adhesive to the top layer and then press the front and rear sections of the gather into place.



Apply jointing adhesive to the joints on the sides of the front and rear panels of the gather.



Press the side panels of the gather into place.



Apply jointing adhesive to the top of the gather unit and then press the top plate into position with the hole offset closer to the rear section of the gather. Ensure the top section is level. Clean off any excess mortar.

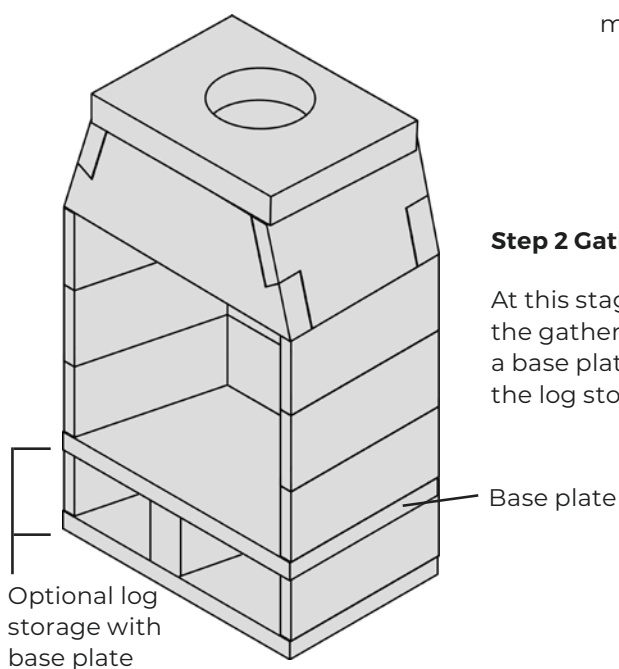

Step 2 Gather Unit section complete

At this stage the Hotham should resemble the image with the gather unit above the three rows of the firechest area, a base plate with the log storage beneath the base plate (if the log storage option is being used).

Instructions - Chimney Blocks (Step 3)



Spread jointing adhesive in the shape of the chimney block.



Press the first chimney block into place, checking it is in the correct position above the hole in the top plate.



Apply jointing adhesive and install the next two chimney blocks, apply adhesive at every joint.



Apply jointing adhesive and install the optional Top Cap (if purchased).

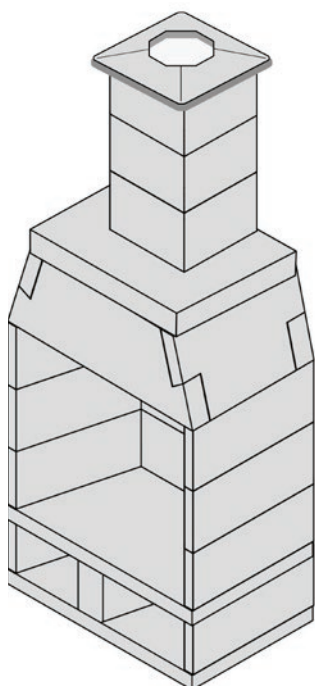

Step 3 Blocks and Top Cap complete

The fireplace is now complete with Chimney Blocks and Top Cap. After the Jointing Adhesive is touch dry, the external rendering stage will commence.

This graphic shows a fireplace with the optional log storage and base plate at the bottom.

Instructions - Rendering (Step 4)



External Render

To be mixed, adhered to the surface and smoothed over by a competent person. As this is heat resistant external render, it requires more care and pressure to spread than traditional render, which is much smoother.

Render is designed for one coat, if you require more coats you will need to purchase more render.



Burn off the fibres on the external surface before rendering.



Mix the render as per the instructions on the bag.



Render the surface areas.



Ensure the edges are smooth and wait to dry.



The finished model, prior to adding firebricks and the log retainer.

Hotham Firebricks Guide

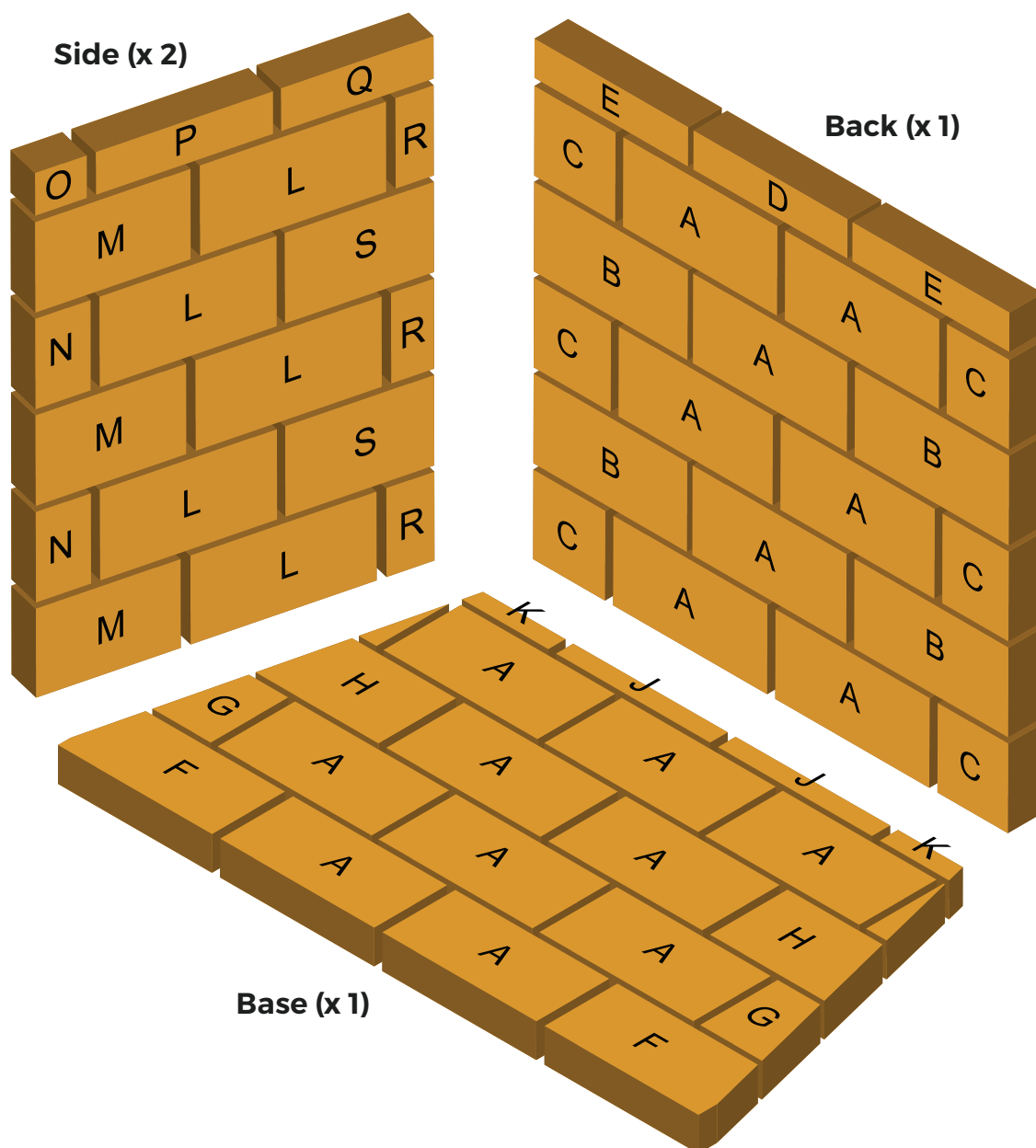

Brick	L	W	D
A	230	114	50
B	214	114	50
C	95	114	50
D	230	52	50
E	214	52	50
F	220	114	50

Brick	L	W	D
G	71	114	50
H	160	114	50
I	15	114	50
J	230	20	50
K	102	20	50
L	230	114	25

Brick	L	W	D
M	156	114	25
N	78	114	25
O	78	52	25
P	230	52	25
Q	156	52	25
R	78	114	25
S	156	114	25

Note for all models

8mm gap between bricks.

Bedded on 1-3mm thick firebrick mortar.

Firebricks to be glued on and pointed with the Calderys firebrick mortar as per enclosed instructions.

Sizes in mm

Instructions - Firebricks (Step 5)

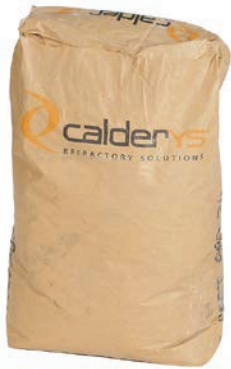

Firebrick Mortar Bag - Used for gluing on firebricks and pointing in. Mix as per instructions on the bag.



Bed the firebricks on to a 3mm layer of firebrick mortar. Use the tables on the previous page as a guide.



Complete the bottom layer of firebricks, then fasten the rear firebricks in place using the firebrick mortar. Use a tile spacer to keep an 8mm gap.



Once the bottom and rear firebricks are in place, fasten the side bricks in position using the firebrick mortar. Use a tile spacer to keep an 8mm gap.



Use the mortar mix to point up the joints between the firebricks once they are all in position.

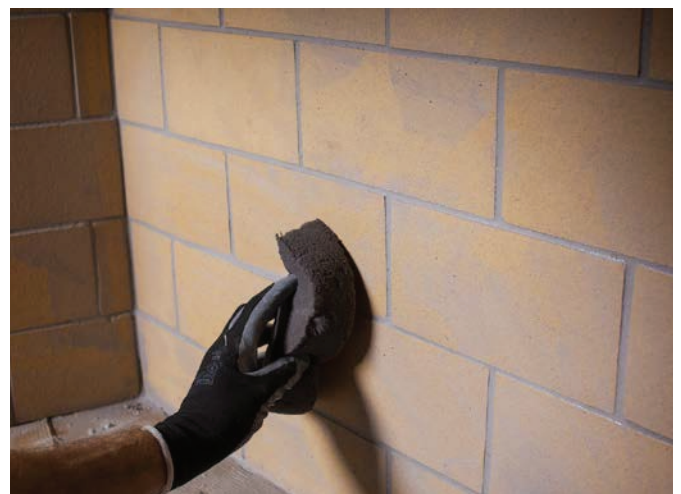

Clean off excess mortar.

Instructions - Log Retainer (Step 6)



Drill 2 x 12mm diameter holes in the front row of the firebricks. Push log retainer holders in place.



Then push fit the log retainer bars into the slots.



Optional Extras - Rain Cap (if purchased)





Rain Cap if purchased.



Bend the steel prongs out so the Rain Cap is a tight push fit into the concrete Top Cap.

	Code	Optional extras
	OLHOTLS	Log Storage
	OLHOTCB	Additional Chimney Blocks
	OLHOTRC	Rain Cap

	Code	Optional extras
	OLHOTCG	Cooking Grill
	OLJA5	Jointing Adhesive
	OLER20	External Render 20kg

There are a range of optional accessories available for this Hotham. Please contact us or your distributor for more details and pricing.

After completion

Once build and external rendering is complete, please do not use for at least 72 hours after completion.

On first use, always light a small fire first and increase the size of the fire once the firechest has fully dried out. Only use dried and seasoned wood for the fire. Do not burn plastic or waste products.

Guarantee

INTRODUCTION

We are confident in our products and so offer you (the owner) a generous guarantee in relation to the Hotham Fireplace.

Provided that you comply in full with your responsibilities (below) and subject to the Small Print (below), we guarantee to you that the fireplace will be free from defects on delivery to you via pallet.

Any blocks or firebricks which are cracked or damaged at the time of delivery will be replaced free of charge. Damage must be reported within 14 days of delivery.

This guarantee does not cover any major impact to the fireplace (such as wear and tear, wind damage) once the item has been constructed and rendered. Due to expansion and contraction, small hairline cracks may appear in time and are considered normal and non-structural.

As the fireplace is an outdoor product, standard wear and tear will occur and any structural damage would have to be investigated. In the unlikely event that the fireplace becomes defective during the guarantee period, we will provide replacement component parts and render material free of charge.

YOUR RESPONSIBILITIES

To benefit from our guarantee, this product will be registered to the address where we delivered it. Please inform us if the fireplace was installed elsewhere.

HOW TO CLAIM UNDER YOUR GUARANTEE

To claim under your guarantee, please email us at sales@ochreliving.com.au. You will be asked to provide proof that you have complied in full with the terms of usage of the fireplace and that only dried and seasoned firewood has been used as a fuel.

If you are an installer / builder

If you are a regular builder of our Ochre Fireplaces, then please get in touch with us. We are looking for competent builders throughout the Australia to promote as "recommended builders" in certain areas.

Builders are able to benefit from joining our Installer Loyalty Scheme with points awarded for installations, which can then be redeemed for vouchers. Please email sales@ochreliving.com.au for details.



OCHRE LIVING

T. 1300 212 213 | www.ochreliving.com.au

Follow us on social media     OchreLivingAU